

CONNECTOR VIEWS ARE FROM WIRE-SIDE OF HOUSING  
 B21 and B22 Views Are Main Harness Views

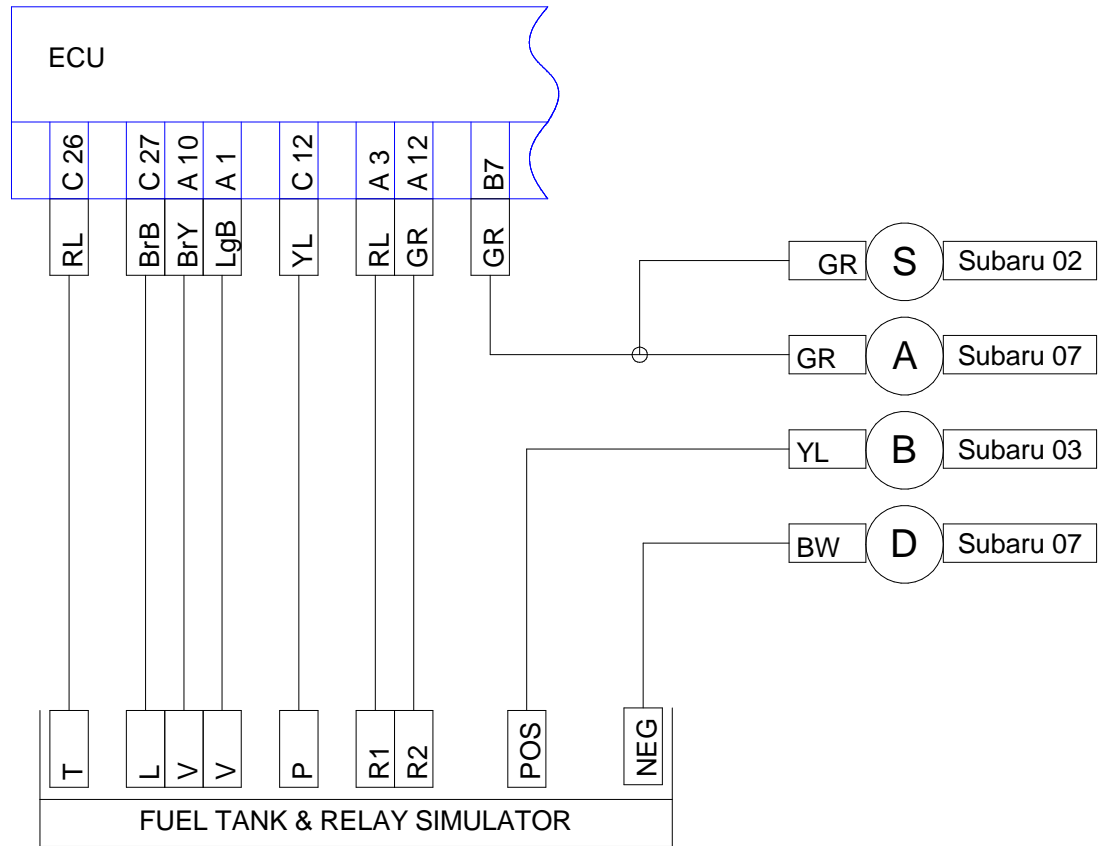

**ECU MAIN CONNECTOR**

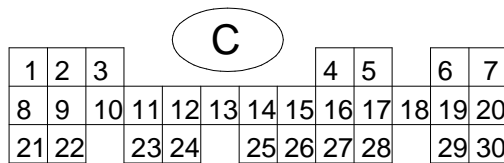
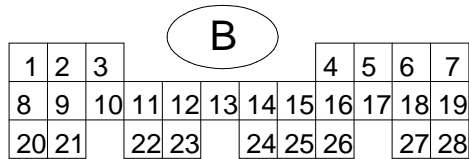
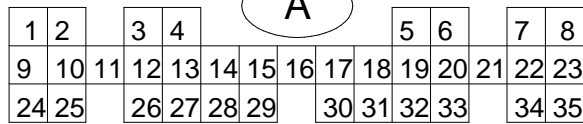
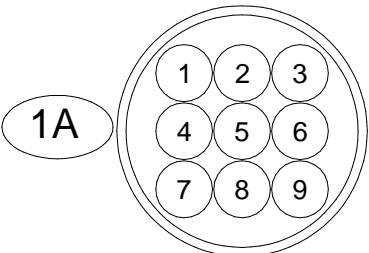

CONNECTED TOGETHER  
 ON BATTERY SIDE OF 1A:

1A Slot	Connected To
1	S5 A1
2	S5 A2
3	Main Batt @ Ess Buss Sw
4	Main Buss O2 +
5	Start Switch
6	Gnd
8	MIL
9	Tach

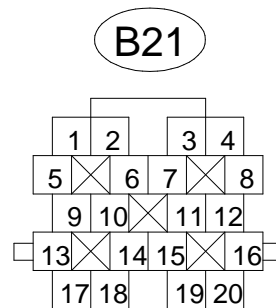
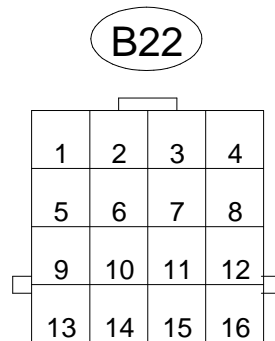

<b>GLASAIR I TD #446</b>			
DRAWN ANDREW PLUNKETT 12-00	SUBARU EFI 1 OF 8		
CHECKED			
ENGINEER ANDREW PLUNKETT 12-00	SIZE	DWG NUMBER <b>0000-0000</b>	
APPROVED	REV -	SHEET 18 of 25	
SCALE			